

# APPLICATIONS WITH ADDITIONAL SPECIFICATIONS OR CONSIDERATIONS

## BONDED INSTALLATION METHOD

Inception may be installed using the bonded installation method contingent that:

- The application is limited to residential use.
- The substrate flatness is well within  $\frac{3}{16}$ " in a 10' radius with no abrupt changes in elevation.
- Grout joints are filled when installing over pre-existing ceramic tile.
- The flooring material, ancillary products, and the jobsite have been acclimated for as long as necessary to reach service-conditions. Acclimation should be done within climate-controlled structures between 65°F - 85°F and 40%-60% ambient RH for a minimum of 48 hours before installation, during installation, and indefinitely thereafter.
- Prevail 3500 Hard-Set Adhesive is used in a semi-wet application. Other adhesives are not approved and should not be used.
- An adhesive bond test is performed prior to the installation of Inception.
- Inception is not bonded and floated within a continuous assembly. A T-molding is required to separate areas of differing application methodologies.

## Additional Unapproved Substrates For Bonded Installations

- Engineered hardwood
- Solid hardwood
- Parquet

## Installation

The room layout must be set-up so that all flooring can be installed while working off of freshly installed planks/tiles. This will keep the product from shifting, minimize adhesive displacement, and prevent wet adhesive from oozing up onto the surface of the product. Determine the starting wall and create work zones that are no wider than the installer's comfortable arm reach and in multiples of the product's width. Measure and snap chalk lines parallel to the starting line and spread adhesive within the work zone. Install Inception using Prevail 3500 per the specifications below. Inception must be installed before the adhesive has become dry-to-touch. Roll each work zone cross directionally with a 100 lb three-section roller immediately after installation. Continue installation by repeating the process until the room is complete.

Newly installed flooring must be protected from foot traffic while the adhesive is setting. Early foot traffic, as well as point or rolling loads, can cause shifting of planks/tiles, adhesive displacement, or breaking of the bond between the adhesive and the product or substrate.

## Absorbent Substrates

Apply adhesive using a  $\frac{1}{16}$ " x  $\frac{1}{16}$ " x  $\frac{1}{16}$ " Square notch trowel (Spread Rate = 125-150 Sq.Ft./Gallon). The flooring material can be immediately placed into the adhesive.

## Non-Absorbent Substrates

Apply adhesive using a  $\frac{1}{16}$ " x  $\frac{1}{16}$ " x  $\frac{1}{16}$ " V notch trowel (Spread Rate = 165 - 200 Sq. Ft./Gallon). The adhesive valleys must begin transitioning to clear before placing flooring material into the adhesive.

## THREE-SEASON ROOMS

Inception may be installed in "three-season rooms" contingent that:

- The application is limited to residential use.
- The assembly does not exceed 500 Sq.Ft. (46.5 Sq.m)
- The space must be completely enclosed (roof, floor, doors, walls, and windows) and not exposed to the outside elements.
- A room temperature between 50°F and 100°F (10°C and 38°C) is maintained during the installation.
- A  $\frac{3}{8}$ " (10 mm) expansion space is provided around the perimeter and all vertical obstructions.

## INSTALLING CABINETS ON TOP OF INCEPTION

Cabinets may be installed on Inception contingent that:

- The application is limited to residential use.
- Cabinets or similar fixtures are not secured, or affixed (via screws, nails, etc.), in a manner which restricts the flooring's ability to expand and contract.
- Proper perimeter expansion space is provided at all walls or other vertical obstructions, including pipes or other objects. This includes any obstructions or objects under, or concealed by, the cabinets.

# FINISH THE PROJECT

1. **Trim Moldings:** Remove all spacers and reinstall moldings and trim, being sure not to restrict the assembly. Inception is a floating floor and must be allowed to expand and contract freely. It should not be nailed or fastened through the flooring and into the substrate or structure.
2. **Transitions:**
  - A reducer, T-molding, end-cap, or stair-nosing is required when transitioning between different flooring-coverings, at appropriate terminations, and other suitable circumstances.
  - Commercial projects require that a T-molding be used in areas greater than 100 ft. (30.48 M) in any direction to divide the assembly into smaller sections.
  - Commercial projects require that T-Molding is used to separate installations in adjoining spaces interconnected by a narrow opening, such as a doorway between rooms.
3. **Clean-up the Jobsite:** Remove any product scraps and tools from the jobsite. Sweep and damp mop the flooring to ensure all dust, dirt, and debris are removed from the surface of the finished flooring.
4. **Wet-Area Expansion Spaces:** Fill expansion spaces around potential wet areas with premium waterproof 100% silicone sealant.
5. **Protect the Floors:** Newly installed flooring must be protected from damage of other trades.
6. **Reset Fixtures and Furniture:** Set fixtures and furniture back in place, ensuring that objects are not slid across the surface of the new flooring.

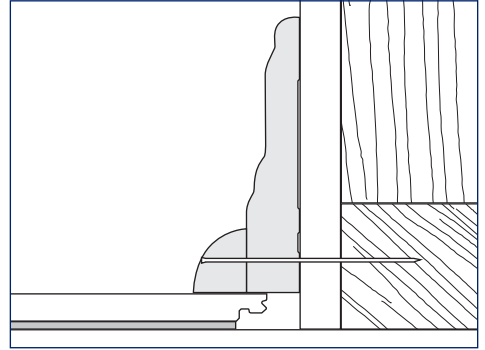

9.

**Install Last Pieces of Rows 1 and 2:**

Measure, mark, and cut the final pieces of rows #1 and #2 ensuring both sides of the rows have proper expansion space. Residential projects require a 1/4" expansion space and commercial projects require a 3/8" expansion space. Place appropriately sized spacers along the left, right, and starting walls. Slide the assembly over and against the spacers along the starting wall.

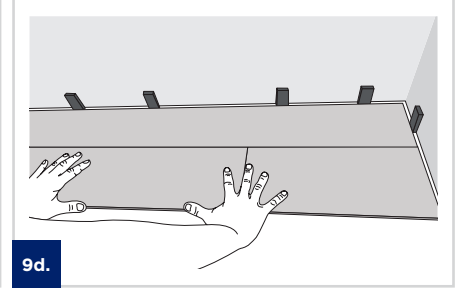
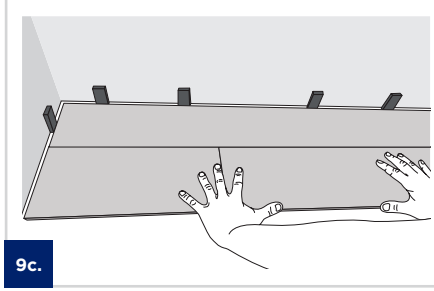
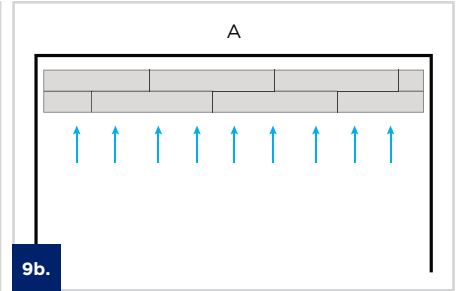
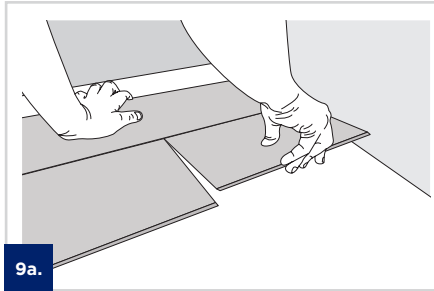

10.

**Install Remaining Rows:**

Install the remaining material, one row after another. Always tap the long joint tight using the Prevail Tapping Block before tapping the short joint down using the soft face hammer. Maintain the required stagger throughout the installation

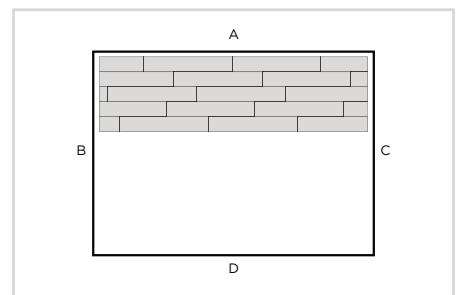

11.

**Install the Final Row:**

Using the scribing block; mark, cut, and install the final row. Always ensure proper expansion is provided. Use a pull bar to fully engage the long joints. Do not use the pull bar on the short edges.

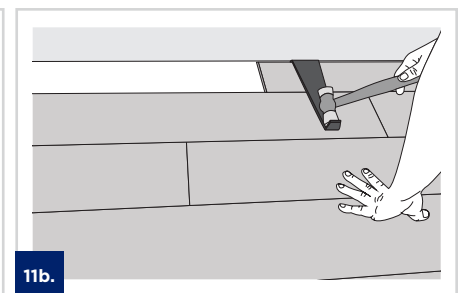
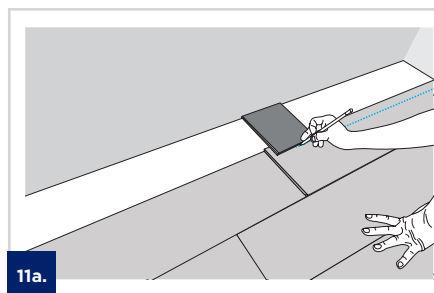

7.

**Sequence of Installation:** Installation will move from left to right, beginning in the left corner while facing the starting wall. The installation will alternate back and forth between rows one and two, for the first two rows only.

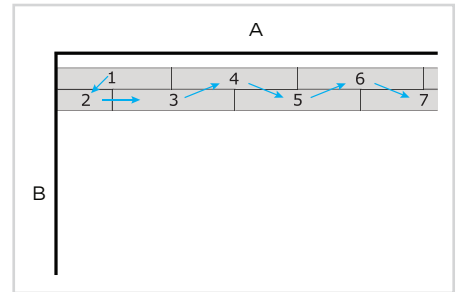

8.

**Install Starting Rows:** Place the first piece of row #1 several inches from the starting wall with the long cut edge facing the starting wall (8a). Cut the first piece of row #2 to one-third its length. Interlock the long tongue-edge of the first piece of row #2 into the long groove-edge of the first piece of row #1, ensuring that there are no gaps (8b). Using a hammer and a Prevail Tapping Block, carefully tap along the long groove edge to fully engage the joints (8c). Install the second piece in row #2 by inserting the long tongue-edge into the long groove-edge of the first piece of row #1. With the piece angled slightly, slide the piece towards the first piece of row #2 until the edges align (8d). Tap the long joint tight using the prevail tapping block, then tap down on the short joint using the soft face hammer (8e). Continue installing rows #1 and #2 until you reach the opposite wall and cannot install another full-length piece (8f). Always make certain the long joints are fully engaged before tapping down the short joints using a soft face hammer.

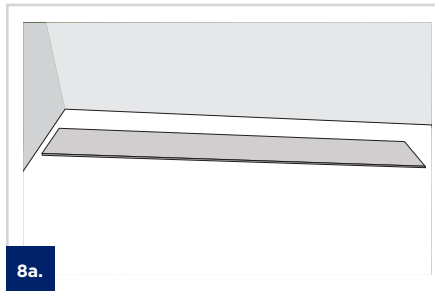

8a.

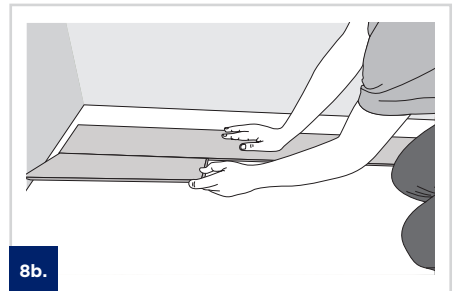

8b.

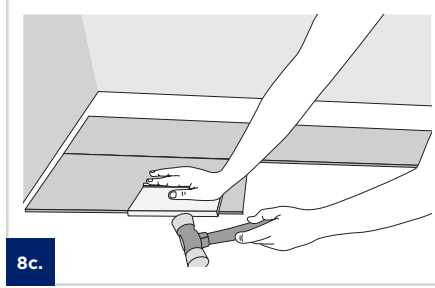

8c.

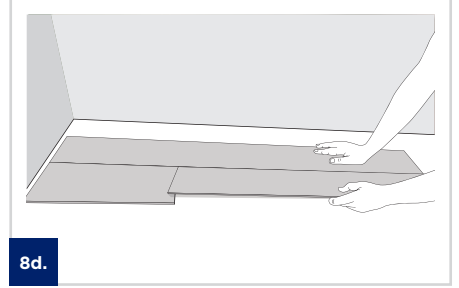

8d.

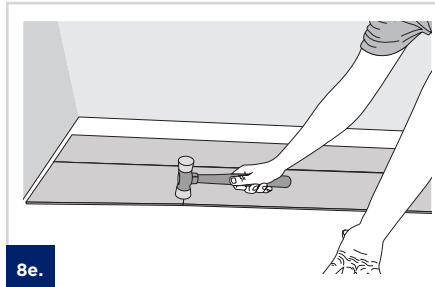

8e.

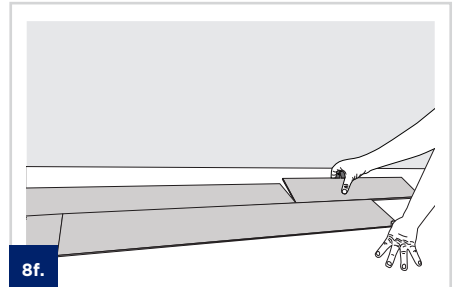

8f.

4.

**Position the First Row:** Place full pieces end-to-end along the starting-line with the long tongue-edge facing the starting wall, without engaging the short joints.

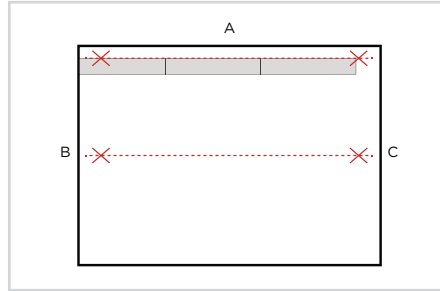

5.

**Mark and Cut First Row:** To transfer the contours of the starting wall onto the first row, a “scribing block” will be necessary. To create a scribing block, first determine the size needed by measuring the width of the flooring (excluding the locking profiles) plus an additional 1/4” for a residential project or 3/8” for a commercial project. Cut a piece of scrap flooring, plywood, or similar material to this measurement. Place the scribing block against the wall; mark a line at the edge of the scribing block. Slide the scribing block along the starting wall while continuing to mark. Carefully cut the marked material on the line, these pieces will be used for row #1.

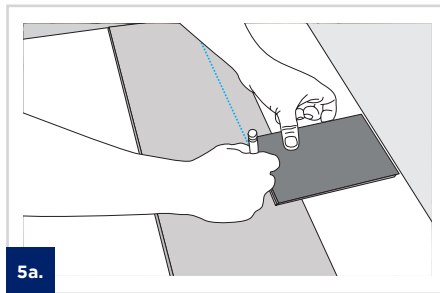

5a.

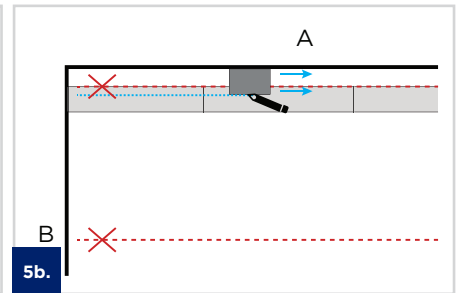

5b.

6.

**Determine Proper Staggering:** Maintain a minimum 6” short-joint stagger from row-to-row throughout the entire installation. (Tile format installations should be staggered in a brick-laid pattern with stagger equal to half of a tile.)

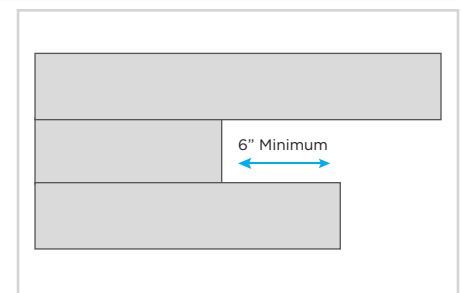

# INSTALLATION OF INCEPTION

## Understanding the Edge Profiles:



1.

**Layout:** The project layout should be discussed with and approved by the architect, designer, general contractor, end-user, and/or homeowner prior to installation of material.

2.

**Balance the Room:** Balance the layout by measuring and marking the center-point on both sides of the room (2a.). Connect the marks using a chalk line to create the centerline of the area. (2b.) (For tile format installations, an additional perpendicular centerline may be necessary to ensure the room is properly balanced on all four sides.)

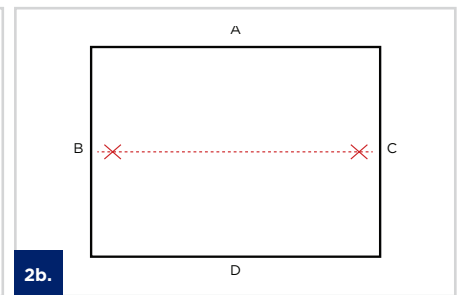
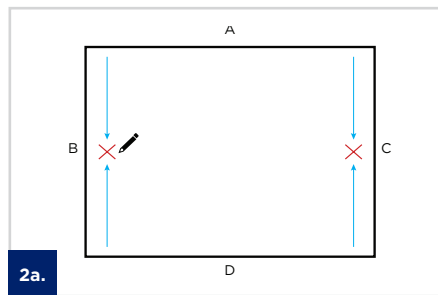

3.

**Establish the Starting Line:** Starting at the centerline, assemble a column of material working toward the starting wall (wall A); continue until no additional full-width pieces can be laid. Place a mark on the substrate along the long edge of the last full-width piece, closest to the starting wall. (3a) Snap an additional chalk line at this location while ensuring that it is perfectly parallel to the centerline. (3b) (Note: If the perimeter pieces are less than half the width of a piece, offset the starting line by shifting away from the starting wall by a distance equal to half the width of a piece.)

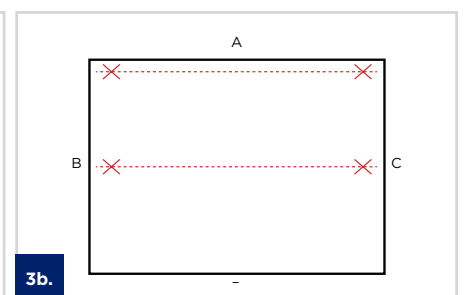
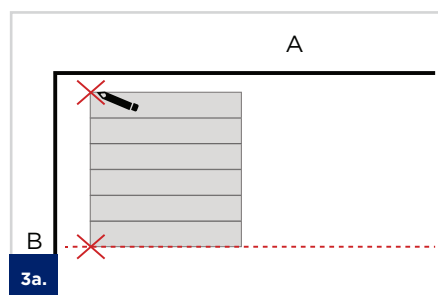

## PREPARE THE PROJECT

1. **Check the HVAC:** Confirm the structure's HVAC system is in full operation. The building should be maintained at service conditions between 50°F and 100°F (10°C and 38°C) at least 48 hours before installation, during installation, and indefinitely thereafter.
2. **Acclimation:** Acclimate the materials, and the jobsite for as long as necessary to reach service-conditions.
3. **Remove Floor Moldings:** Quarter round and/or wall base should be carefully removed before installation begins.
4. **Remove Unapproved Substrates:** Unapproved substrates and adhesives cannot be installed over and must be removed.
5. **Evaluate the Substrate:** Check the substrate for flatness, excess moisture, levelness, and ensure the structure is sound and free of excessive deflection.
6. **Perform Substrate Preparation:** Perform all necessary preparations to ensure the project is in compliance with all aforementioned specifications.
7. **Door Jambs & Casings:**
  - a. **Wood door jambs** and casings should be undercut so that Inception will fit neatly beneath, concealing the expansion space.
  - b. **Metal door jambs** may need to be left undisturbed. In such instances, Inception must be cut around the jambs and casings, leaving the appropriate expansion space. Fill the expansion space with a coordinating premium waterproof flexible sealant, such as 100% silicone, upon completion of the project.
8. **Clean the Substrate:** Sweep and vacuum the substrate to remove all dust, dirt, and debris.
9. **Perform Final Qualification:** Perform a final acceptance inspection of the substrate and project. Make sure the substrate is completely clean, dry, smooth, flat, and all necessary preparations have been properly completed and documented. Installation of flooring acknowledges acceptance of material and project conditions.

## UNAPPROVED SUBSTRATES

The substrates listed below are not approved and must be removed, including any underlying adhesives, prior to installation. Pre-existing adhesives must be removed so all that remains is a thin, smooth film. The remaining film should be properly encapsulated using an appropriate floor patching compound or completely removed by a non-chemical method such as shot blasting or grinding.

- Carpet or Carpet Cushion
- Cushion Back Sheet Vinyl
- Floating Floors
- Engineered Hardwood Over Concrete
- Solid Hardwood Over Concrete
- Parquet Over Concrete
- Sleeper Substrates

**NOTE:** Various federal, state, and local government agencies have established regulations governing the removal of in-place asbestos-containing material. If you contemplate the removal of a resilient floor covering structure that contains (or is presumed to contain) asbestos, you must review and comply with all applicable regulations. Do not sand, dry sweep, dry scrape, drill, saw, bead blast, or mechanically chip or pulverize existing resilient flooring, backing, lining felt, asphalt "cut-back" adhesive, or other adhesives. These products may contain asbestos fibers and/or crystalline silica. Avoid creating dust. Inhalation of such dust is a cancer and respiratory tract hazard. Smoking by individuals exposed to asbestos fibers greatly increases the risk of bodily harm. Unless positively certain that the product is a non-asbestos containing material, you must presume it contains asbestos. Regulations may require that the material be tested to determine asbestos content. The RFCI's Recommended Work Practices for Removal of Resilient Floor Covering are a defined set of instructions addressed to the task of removing all resilient floor covering structures. For further information, contact the Resilient Floor Covering Institute website at [www.rfci.com](http://www.rfci.com).

## SUBSTRATE PREPARATION

Inception must be installed on a properly prepared substrate. The selection of preparation products is dependent upon the circumstances of each project. The application of all products must be performed in strict accordance with the respective manufacturer's instructions. Responsibility for the performance or suitability of any preparation or ancillary product including, wood underlayments, moisture mitigation/management systems, floor patching compounds, self-leveling underlayments, sealers, primers, and other such items rests with the manufacturer of the ancillary product or the flooring contractor.

**Inception includes an integrated pre-attached pad, use of additional underlayment pad is not permitted.**

## MATERIAL STORAGE, ACCLIMATION, AND INSPECTION

**Warehousing:** Store all materials flat and off the floor in a climate controlled, weather-tight space between 50°F and 100°F (10°C and 38°C). Do not double-stack pallets.

**Delivery:** Make sure materials are well secured during transit to avoid preventable damage.

**Handling:** Always exercise caution when handling cartons, being careful not to damage material.

**Job Site Storage/Staging:** Immediately remove any shrink-wrap and place materials within the project to acclimate to service conditions. Store all materials flat, fully supported, and placed into well-aligned stacks. Make certain the stacks are no more than six (6) cartons high and at least 4" apart. Cartons should never be stored or left standing on end. Keep cartons away from heating/cooling ducts, direct sunlight, or any other source of extreme temperatures. If permanent HVAC is not yet in operation, temporary means should be used to maintain the noted temperature and RH.

**Temporary Heating:** Only suitable temporary HVAC systems should be used, which may include electrical heat or direct-vent heating systems. The use of any propane or kerosene forced-air heaters, any vent-free or ventless heaters, and/or any other type of unvented fuel-burning heating systems is not permitted. Temporary heating must be in constant operation until a permanent HVAC system is fully operational. It is recommended that projects installed while using temporary heating have supporting documentation of the environmental conditions before, during, and after the installation.

**Acclimation:** Acclimation of the flooring material is recommended for all projects; however, only commercial installations require acclimation. The flooring material, ancillary products, and the project area should be acclimated for as long as necessary to reach service-conditions. Acclimation should be done within climate-controlled structures between 50°F and 100°F (10°C and 38°C) and 40%-60% ambient RH for a minimum of 48 hours before installation, during installation, and indefinitely thereafter.

**Confirmation:** Confirm that the material is of the correct style, color, quantity, and run number. Locate the run number on the short end of each carton and verify that all the materials are of the same run number. Minor shade variations within the same run number contribute to the natural look of Inception. To avoid noticeable shade variations, do not install material of different run numbers across large expanses.

**Inspection:** Prior to installation, check material for defect or damage.

**Notification:** Always report any damage, concerns, or discrepancies to the retailer from which the floor was purchased. If any issues have been identified, the installation should not progress until all matters have been resolved.



# PRE-INSTALLATION ESSENTIALS

*Your job will be smooth, fast and easy when you follow the essentials every time you install Inception.*

## EVALUATE THE PREMISES

### Exterior

A proper inspection should be completed, prior to installation, by a qualified individual to ensure:

- Driveways and landscaping surrounding the building direct water away from the foundation.
- Gutters, down spouts, and drains are free of blockage, allowing runoff to flow freely away from the foundation.
- Crawl spaces have cross-ventilation air vents equaling at least 1.5% per 100 Sq.Ft. (9.3 Sq.m) of floor space.
- Crawl space elevations should measure a minimum of 18" (46cm) and should be insulated according to the latest building code requirements. The ground should be covered with a minimum 6-mil vapor barrier.
- Inception should not be installed in locations where the space beneath the building structure is openly exposed to the outside elements.
- All permanent exterior doors and windows have been properly installed.

### Interior

- Inception is only intended for interior use.
- Examine the installation site for faulty plumbing, including leaks from water heaters, dishwashers, washing machines, or any other water-bearing fixtures or pipes.
- Inception is waterproof, but it is not a substitute for proper moisture management. Inception cannot inhibit the growth of mold or prevent structural problems associated with, or caused by flooding, excessive moisture, alkalis in the substrate, moisture vapor emissions, or conditions arising from hydrostatic pressure. Substrate moisture issues should be addressed and corrected prior to installation.
- Permanent HVAC system should be in full operation at least one week prior to installation. Room temperature should be maintained between 50°F and 100°F (10°C and 38°C) at least 48 hours before installation, during installation, and indefinitely thereafter.
- All other trades must complete their respective work before installing Inception.

ATTENTION: Mold and mildew grow only in the presence of moisture. Moisture issues on the project should be addressed and corrected prior to installation. Please visit [www.epa.gov/mold](http://www.epa.gov/mold) for information about safely preventing and removing mold, mildew, and other biological pollutants.

## EVALUATE AND QUALIFY YOUR SUBSTRATE

All substrates, regardless of composition, must be in accordance with ASTM F2678 and in strict compliance with the following guidelines:

**Grade:** Inception is suitable for above-grade, on-grade, and below-grade applications.

**Floor Flatness:** Substrates must be flat within  $\frac{3}{16}$ " (4.76mm) in a 10' (3.05m) radius.

**Floor Levelness:** Substrates must not slope more than 1" (25.4mm) per 6' (1.83m) in any direction.

**Smooth:** Substrates shall be smooth and free of irregularities, roughness, excessive texture, or abrupt changes in elevation.

**Dry:** Substrates must be free of excess moisture. Concrete substrates must measure no more than 8lb MVER per 1,000 Sq.Ft. in 24 hours in accordance with ASTM F1869, or 85% RH when measured in accordance with ASTM F2170, with alkalinity levels between 7 and 10. Wood substrates must not exceed 14% when measured with an appropriate moisture meter.

**Clean:** Substrates must be free of any contaminants, bond-breakers, deleterious substances and other foreign materials that could reduce adhesion, impair performance, affect the rate of moisture dissipation from the substrate, or cause a discoloration of the flooring. This would include, but not limited to, dust, solvent, paint, wax, oil, grease, residual adhesive, adhesive remover, film-forming curing compound, silicate penetrating curing compound, dissipative curing compounds, sealing compound, hardening compound, parting compound, alkaline salts, excessive carbonation or laitance, mold, and mildew.

**Structurally Sound:** Structures must be free from flaw, deficiency, defect, decay, or deterioration and in compliance with all applicable building codes.

**Free of Excessive Deflection:** The maximum allowable deflection of the structure or substrate must not exceed L/360.

## Concrete Substrates

**General Conditions:** All concrete floors, regardless of age or grade level must be properly cured and prepared in accordance with the most current version of ASTM F710 (Standard Practice for Preparing Concrete Floors to Receive Resilient Flooring). Concrete substrates must have compression strength of 3,000 psi or greater. Below-grade and on-grade concrete substrates must have a suitable and uncompromised vapor retarder properly installed beneath the slab (ASTM E1745).

**Contaminant Removal:** Non-chemical methods for removal, such as scraping, abrasive cleaning, grinding, bead or shot blasting, including methods described in ASTM D4259 (Standard Practice for Abrading Concrete), may be used on pre-existing slabs with deleterious residues or other contaminants. ***The use of adhesive removers or solvents (including soy and citrus type products) is strictly prohibited.***

**Moisture and Alkalinity:** Moisture and alkalinity tests should be performed on all concrete substrates regardless of grade level or age of slab. Perform either ASTM F2170 In-Situ Relative Humidity (RH) test or ASTM F1869 Calcium Chloride Moisture Test. RH Test results should not exceed 85% relative humidity. The Calcium Chloride Test for moisture should measure no more than 8 lb per 1,000 Sq.Ft. in 24 hours Moisture Vapor Emission Rate (MVER). All moisture tests should be conducted prior to installation to ensure that moisture is at recommended levels. If test results exceed recommended tolerances for moisture, the area must be allowed to further dry to an acceptable level or remediated using a moisture-mitigation system before installing Inception. Electronic meter testing is not a replacement for a Calcium Chloride Test or Relative Humidity Test. Perform pH tests per ASTM F710 to determine alkalinity of the slab, pH tests for alkalinity levels should register between 7 and 10. Rinsing and vacuuming with clean, potable water is the best way to lower surface pH, but it will not prevent future issues. Do not acid rinse concrete floors to neutralize pH. Some moisture-mitigation systems are designed to control pH. It is highly recommended that substrate moisture and pH testing be conducted by an International Concrete Repair Institute (ICRI) certified technician.

**Moisture Mitigation:** Concrete substrates that exceed the maximum moisture value should be brought into compliance prior to the installation of Inception. Due to the complexities associated with concrete moisture vapor emissions and movement of soluble salts in concrete substrates, Metroflor Corporation does not approve or warrant any specific product. When addressing moisture concerns, it is strongly recommended to use products that meet the criteria listed in ASTM F3010 (Standard Practice for Two-Component Resin Based Membrane-Forming Moisture Mitigation Systems for Use Under Resilient Floor Coverings.)

**Vapor Barrier:** A 6-mil polyethylene film may be used under Inception installed over a concrete substrate, however, is not necessary when the moisture content of the concrete slab does not exceed 85% RH or 8 lb MVER. Instances in which the

moisture content of the slab exceeds 85% RH or 8 lb MVER, a 6-mil polyethylene film may be used as an alternative to a comprehensive moisture mitigation system.

Concrete substrates must meet all requirements prior to the application of a polyethylene film. The film should be positioned such that it runs 2" up all vertical obstructions. Adjacent sections of polyethylene film must overlap one another by a minimum of 4 to 6 inches. Smooth out any wrinkles or creases in the film and apply an appropriate premium clear tape to seal the overlapping seams. Ensure that the film remains undamaged before installation, during installation, and continuously thereafter. Once the installation of Inception is complete, trim the polyethylene film flush with the surface of the flooring.

6-mil polyethylene film should not be used in bonded applications or when installing over wood substrates. The use of a 6-mil polyethylene film may present a slip hazard; always follow the appropriate safety practices including those set forth by OSHA

## Radiant Heat Assemblies

Radiant heating systems must be cast a minimum of ½" (12.7mm) below the surface of the substrate and should be operating at least two weeks before installing Inception. 48 hours prior to installations, set the heating system temperature to 68°F (20°C). The temperature of the radiant heat floor may be increased gradually 72 hours after installation, but the surface temperature of the substrate should never exceed 85°F (29°C). Contact the manufacturer of your radiant heating system for further recommendations.

## Plywood, OSB and Particleboard

Wood substrates must be A.P.A. approved with a minimum grade of "BB" or "CC" and be well fastened to the structure. All wood substrates must be checked for moisture. Even if obvious signs are not present, the material should be tested using the appropriate moisture meter; moisture levels should not exceed 14%. Obvious signs of moisture issues may include warping, peaking, degradation of the integrity of the substrate, rusted fasteners, and rusted floor registers.

## Ceramic Tile, Terrazzo, Resilient Tile, Non-Cushion Sheet Vinyl, and Metal

Pre-existing coverings must be well bonded to the underlying substrate. When installing Inception in commercial settings, fill in grout joints and imperfections on ceramic tiles, quarry tiles, terrazzo, and similar floors with an appropriate floor patching compound. In most cases, filling grout joints is not required for residential applications. Grout joints will need to be filled in bonded applications. Always ensure compliance with substrate flatness tolerances.

# KEY INSTALLATION CONSIDERATIONS

	RESIDENTIAL	COMMERCIAL
<b>Substrate Flatness Tolerances</b>	$\frac{3}{16}$ " (4.76mm) in a 10' (3.05m) radius without any abrupt height variations and sloped no more than 1" (25.4mm) per 6' (1.83m)	$\frac{3}{16}$ " (4.76mm) in a 10' (3.05 M) radius without any abrupt height variations and sloped no more than 1" (25.4mm) per 6' (1.83m)
<b>Is a Vapor Barrier Required?</b>	No - A vapor barrier, such as a 6-mil polyethylene film, is not required but may be used	No - A vapor barrier, such as a 6-mil polyethylene film, is not required but may be used
<b>Is Underlayment Pad Required</b>	No - Inception includes an integrated pre-attached pad. An additional underlayment pad is not required and should not be used.	No - Inception includes an integrated pre-attached pad. An additional underlayment pad is not required and should not be used.
<b>Acclimation</b>	Not Required*	A minimum of 48 hours
<b>Transition Requirements</b>	The use of a reducer, T-molding, end-cap, or stair-nosing is required when transitioning between different flooring-coverings, at appropriate terminations, and other suitable circumstances.	<b>General:</b> See "Residential" Requirements <b>Large Areas:</b> Expanses greater than 100 ft. (30.48 M) in any direction will require a T-molding transition to divide the assembly into smaller sections. <b>Adjoining Areas:</b> T-Molding is required to separate installations in adjoining spaces interconnected by a narrow opening, such as a doorway between rooms.
<b>Installation Over Existing Ceramic Tile Floor</b>	Filling grout joints not required ** Ensure compliance with substrate flatness tolerances	Filling grout joints required
<b>Bonded Installation</b>	Approved**	Not permitted
<b>Substrate RH/MVER</b>	Not to exceed 85% RH or 8lbs MVER	Not to exceed 85% RH or 8lbs MVER
<b>Radiant Heat</b>	Approved - Substrate surface temperature not to exceed 85° F	Approved - Substrate surface temperature not to exceed 85° F
<b>3-Season/Non-Climate Controlled Environments</b>	Not to Exceed 500 Sq.Ft. (46.45 Sq.m)**	Not permitted
<b>Perimeter Expansion Requirements</b>	$\frac{1}{4}$ " (6.35mm) expansion at perimeter walls and vertical obstructions **	$\frac{3}{8}$ " (9.5mm) expansion at perimeter walls and vertical obstructions
<b>Ambient Interior Conditions</b>	50°F - 100°F / 40% - 60% Atmospheric RH**	50°F - 100°F / 40% - 60% Atmospheric RH
<b>Definition of "Waterproof"</b>	Structural integrity of Inception will not degrade due to contact with moisture/water***	Structural integrity of Inception will not degrade due to contact with moisture/water***

\* Acclimation of Inception flooring should be considered a best work practice, but is generally not required in residential applications. Installation performed in extremely hot or cold conditions can cause the material to become too flexible or rigid, making the material difficult to install and potentially causing damage to the locking system.

\*\* See Applications with Additional Specifications or Considerations section.

\*\*\*While Inception is waterproof, it is not intended to manage moisture or for use as a moisture mitigation system.

**NOTICE:** Metroflor Corporation does not warrant Inception when installed with customized or modified plank edges and/or locking profiles. This would include instances such as 45-degree mitered corners and serpentine edges. Please refer to the Inception warranty for complete warranty details and exclusions.